

# FENCE OUTSIDE VIEW

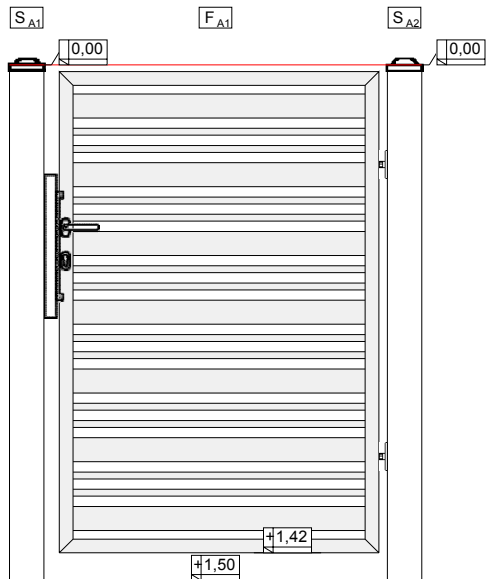

[m]

[m]

| AW.10.107 |      |
|-----------|------|
| So        | 1000 |
| H         | 1400 |
| a         | 250  |
| b         | 300  |
| c         | 0    |

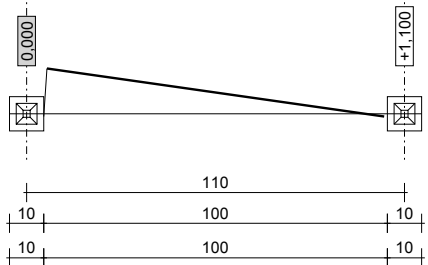

[m]

[cm]

LEGEND: S(So) – element width [mm]; H – element height [mm]; a – upper crossbar position (for WP and Wk taken together with the arch) [mm];  
b – lower crossbar position [mm]; c – arch height [mm]

|   |   |                                      |   |                           |
|---|---|--------------------------------------|---|---------------------------|
| <br><small>All rights reserved</small> | <b>OBJECT</b><br>Section A - 1 with 1       |                                      | <b>DESIGN UNIT</b><br>Skandinaviska Omradesskydd AB<br>Kilowattvägen 12<br>13644 HANDEN<br>Tel/fax: +46 (0)8 50011530 | <b>DATE</b><br>2014-08-20 |
|   | <b>INVESTMENT ADDRESS</b>                   | <b>INVESTOR</b><br>Modern - modeller | <b>SCALE</b><br>1:22  |                           |
|   | <b>DRAWING SUBJECT</b><br>Modern - modeller |                                      | <b>DESIGNED BY</b><br>webpartner1   | <b>DRAWING NO.</b><br>1/4 |

Project designed in "AW Expert" v.2.07.16 - All rights reserved.  
 Using AW Expert application contrary to the terms and conditions of the license agreement shall constitute an application copyright infringement resulting in legal actions stipulated in the Act on Copyright and Related Rights of 4 February 1994. The program is also subject to protection under the European Union and Council Directive 2009/24/WE of 23 May 2009 on the legal protection of computer programs.

# FENCE OUTSIDE VIEW

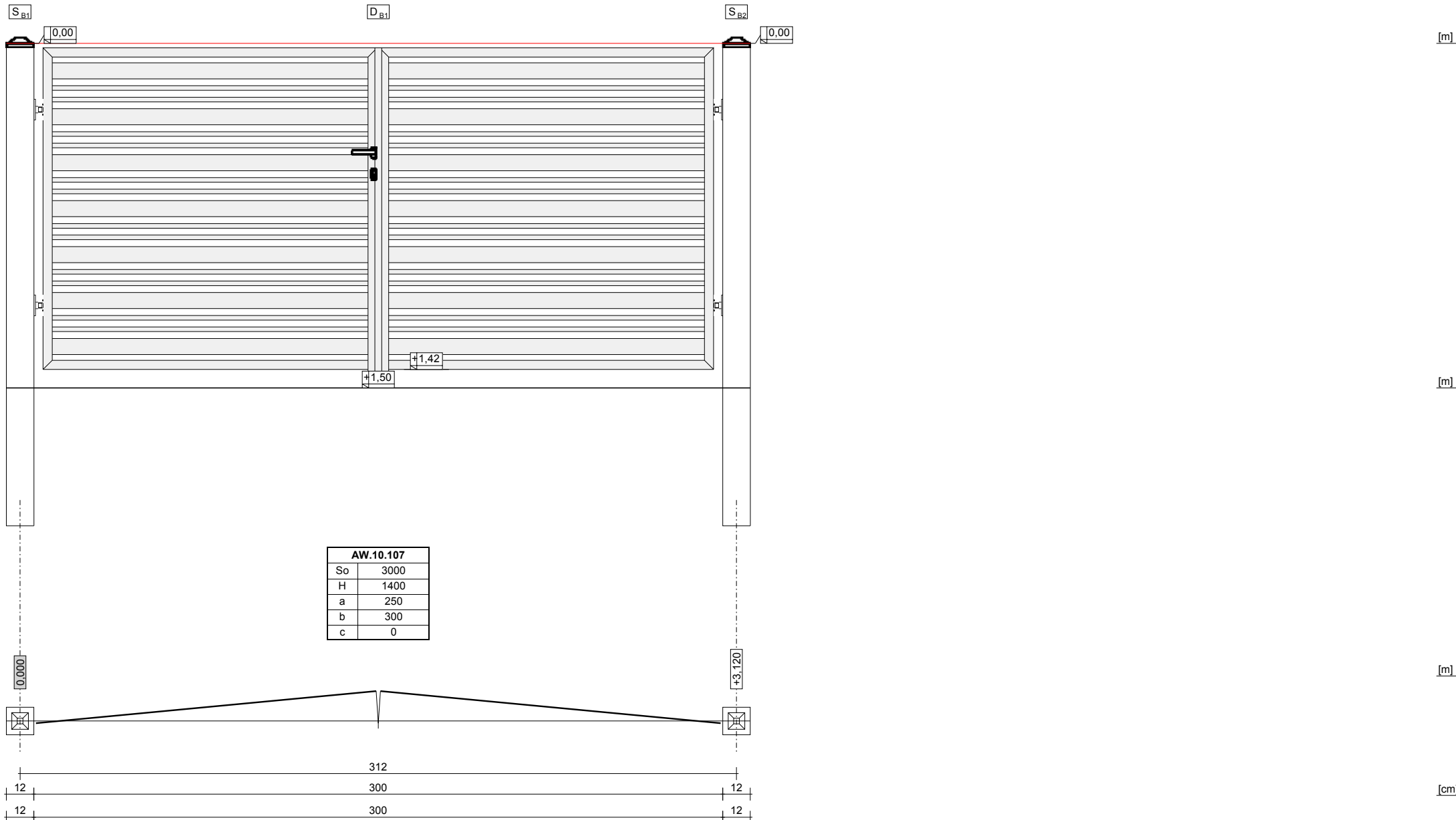

LEGEND: S(So) – element width [mm]; H – element height [mm]; a – upper crossbar position (for WP and Wk taken together with the arch) [mm];  
 b – lower crossbar position [mm]; c – arch height [mm]

|   |                           |                    |                               |              |
|---|---------------------------|--------------------|-------------------------------|--------------|
| <br><small>All rights reserved</small> | <b>OBJECT</b>             |                    | <b>DESIGN UNIT</b>            | <b>DATE</b>  |
|   | Section B - 1 with 1      |                    | Skandinaviska Omradesskydd AB | 2014-08-20   |
|   | <b>INVESTMENT ADDRESS</b> | <b>INVESTOR</b>    | Kilowattvägen 12              | <b>SCALE</b> |
|   |                           | Modern - modeller  | 13644 HANDEN                  | 1:22         |
|   | <b>DRAWING SUBJECT</b>    | <b>DESIGNED BY</b> | <b>DRAWING NO.</b>            |              |
|   | Modern - modeller         | webpartner1        | 2/4                           |              |

Project designed in "AW Expert" v.2.07.16 - All rights reserved.  
 Using AW Expert application contrary to the terms and conditions of the license agreement shall constitute an application copyright infringement resulting in legal actions stipulated in the Act on Copyright and Related Rights of 4 February 1994. The program is also subject to protection under the European Union and Council Directive 2009/24/WE of 23 May 2009 on the legal protection of computer programs.

# FENCE OUTSIDE VIEW

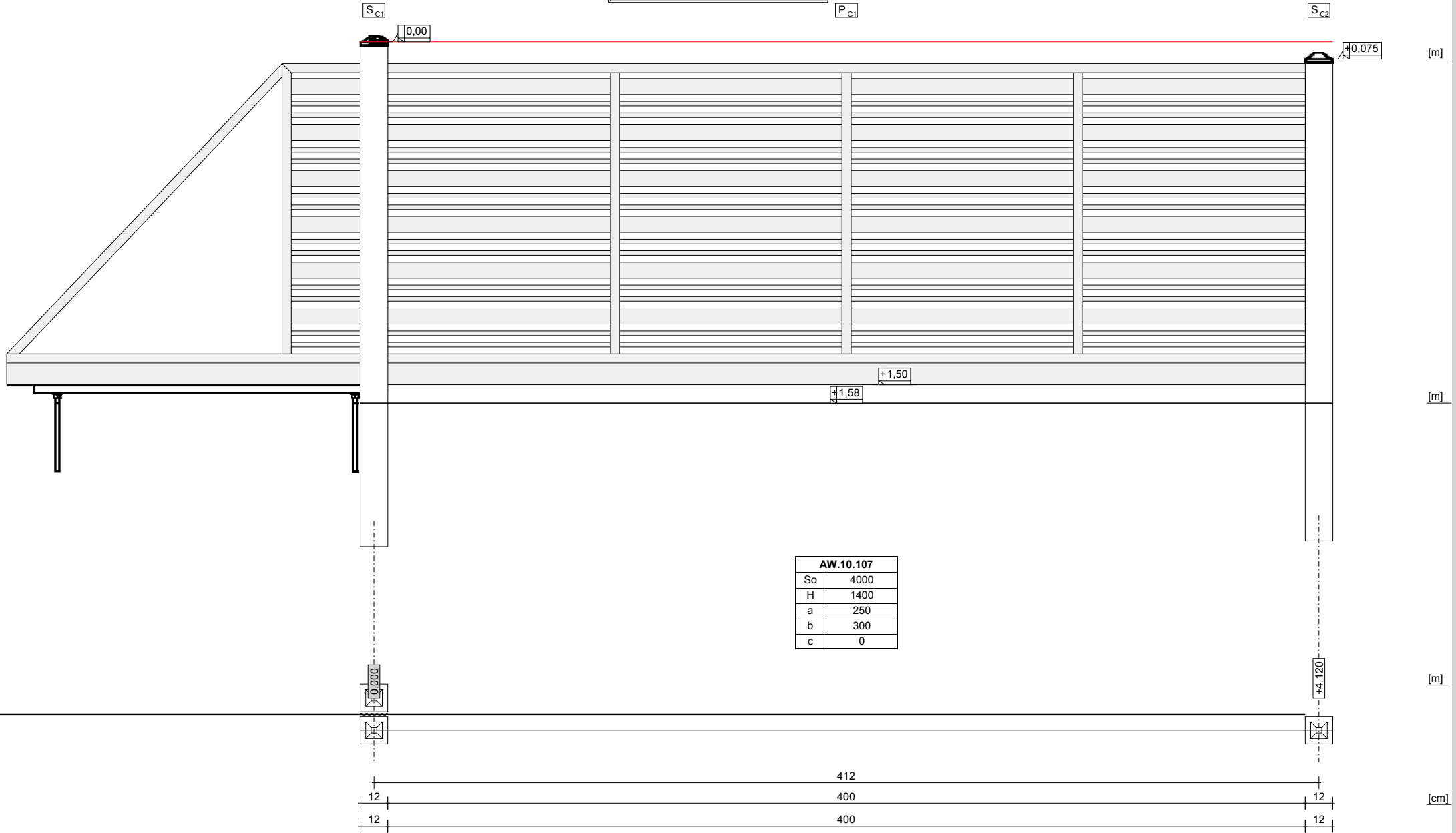

LEGEND: S(So) – element width [mm]; H – element height [mm]; a – upper crossbar position (for WP and Wk taken together with the arch) [mm];  
 b – lower crossbar position [mm]; c – arch height [mm]

|   |   |                                      |   |                           |
|---|---|--------------------------------------|---|---------------------------|
| <br><small>All rights reserved</small> | <b>OBJECT</b><br>Section C - 1 with 1       |                                      | <b>DESIGN UNIT</b><br>Skandinaviska Omradesskydd AB<br>Kilowattvägen 12<br>13644 HANDEN<br>Tel/fax: +46 (0)8 50011530 | <b>DATE</b><br>2014-08-20 |
|   | <b>INVESTMENT ADDRESS</b>                   | <b>INVESTOR</b><br>Modern - modeller | <b>DESIGNED BY</b><br>webpartner1   | <b>SCALE</b><br>1:22      |
|   | <b>DRAWING SUBJECT</b><br>Modern - modeller |                                      | <b>DRAWING NO.</b><br>3/4   |                           |

Project designed in "AW Expert" v.2.07.16 - All rights reserved.  
 Using AW Expert application contrary to the terms and conditions of the license agreement shall constitute an application copyright infringement resulting in legal actions stipulated in the Act on Copyright and Related Rights of 4 February 1994. The program is also subject to protection under the European Union and Council Directive 2009/24/WE of 23 May 2009 on the legal protection of computer programs.

# FENCE OUTSIDE VIEW

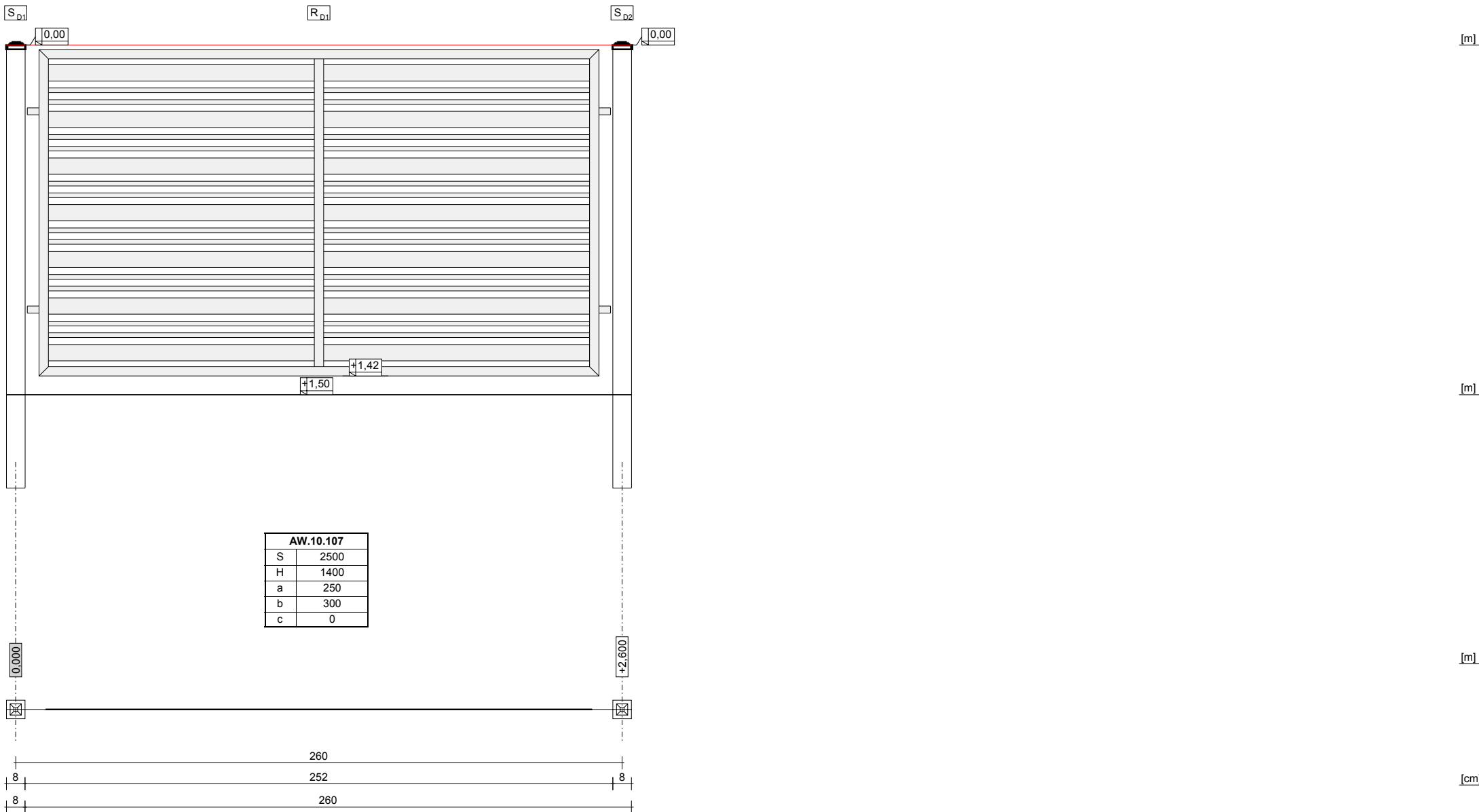

| AW.10.107 |      |
|-----------|------|
| S         | 2500 |
| H         | 1400 |
| a         | 250  |
| b         | 300  |
| c         | 0    |

LEGEND: S(So) – element width [mm]; H – element height [mm]; a – upper crossbar position (for WP and Wk taken together with the arch) [mm];  
 b – lower crossbar position [mm]; c – arch height [mm]

Project designed in "AW Expert" v.2.07.16 - All rights reserved.  
 Using AW Expert application contrary to the terms and conditions of the license agreement shall constitute an application copyright infringement resulting in legal actions stipulated in the Act on Copyright and Related Rights of 4 February 1994. The program is also subject to protection under the European Union and Council Directive 2009/24/WE of 23 May 2009 on the legal protection of computer programs.

|  |   |                                      |   |                           |
|--|---|--------------------------------------|---|---------------------------|
|  | <b>OBJECT</b><br>Section D - 1 with 1         |                                      | <b>DESIGN UNIT</b><br>Skandinaviska Omradesskydd AB | <b>DATE</b><br>2014-08-20 |
|  | <b>INVESTMENT ADDRESS</b><br>Kilowattvägen 12 | <b>INVESTOR</b><br>Modern - modeller | 13644 HANDEN<br>Tel/fax: +46 (0)8 50011530          | <b>SCALE</b><br>1:22      |
|  | <b>DRAWING SUBJECT</b><br>Modern - modeller   |                                      | <b>DESIGNED BY</b><br>webpartner1                   | <b>DRAWING NO.</b><br>4/4 |

AW EXPERT

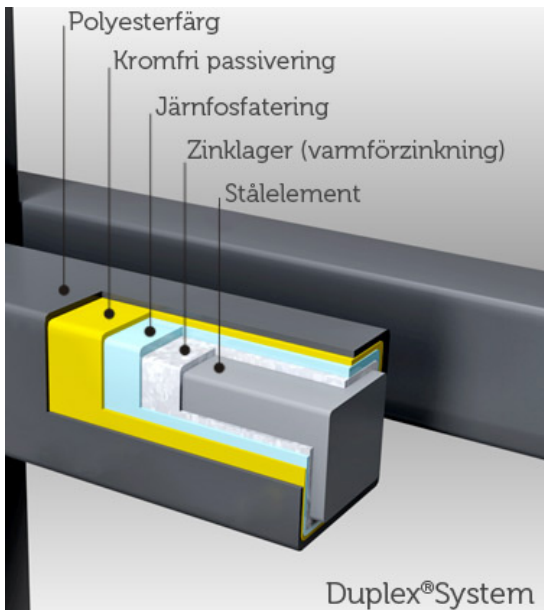

## KVALITET

Alla våra smidesprodukter har ett dubbelt ytskydd – så kallat Duplex-System – som garanterar hållbarheten.

Varje del är varmförzinkad, vilket innebär att hela produkten doppats i smält zink som trängt in överallt och skyddar stålet mot rostangrepp. Zinklagent ger motståndskraft för både höga och låga temperaturer, samt UV-strålning. Dessutom är produkterna pulverlackade i flera omgångar för att ytterligare öka skydd och hållbarhet. En första lackning görs med fosfat och silan som ökar vidhäftningsförmågan inför den avslutande färglackningen.

### 10 års rostskyddsgaranti

Vi lämnar alltid tio års rostskyddsgaranti på alla våra smidesprodukter, eftersom vi vet att de håller och fortsätter att vara vackra i betydligt fler år än så.

## FÄRGER

Våra polyesterfärger håller absolut högsta kvalitet och uppfyller alla krav enligt europeiska standarder (QUALICOAT och GSB). Alla våra smidesprodukter finns i sju standardfärger och ett antal specialfärger, men går också att få lackade i helt valfri RAL-färg.

I grundutförandet är alla smidesprodukter galvaniserade, men du kan välja fritt om och hur ditt staket ska lackas. Mest fördelaktigt pris har våra standardfärger.

### STANDARDFÄRGER:



### ÖVRIGA FÄRGER:



### SPECIELLA FÄRGER:

