

AW.10.66/Wp

(S) 2500 [mm] x (H) 1100 [mm] - 26 kg	(S) 2500 [mm] x (H) 1450 [mm] - 30 kg
(S) 2500 [mm] x (H) 1200 [mm] - 27 kg	
max: (S) 2700 [mm] x (H) 1750 [mm]	

$a=300, b=300, c=150, d=150, x=300, H_{min}=1100$

AW.10.66/P

(S) 2500 [mm] x (H) 950 [mm] - 25 kg	(S) 2500 [mm] x (H) 1450 [mm] - 31 kg
(S) 2500 [mm] x (H) 1200 [mm] - 28 kg	
max: (S) 2700 [mm] x (H) 1600 [mm]	

$a=150, b=300, d=150, x=300, H_{min}=950$

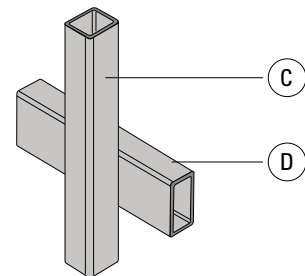
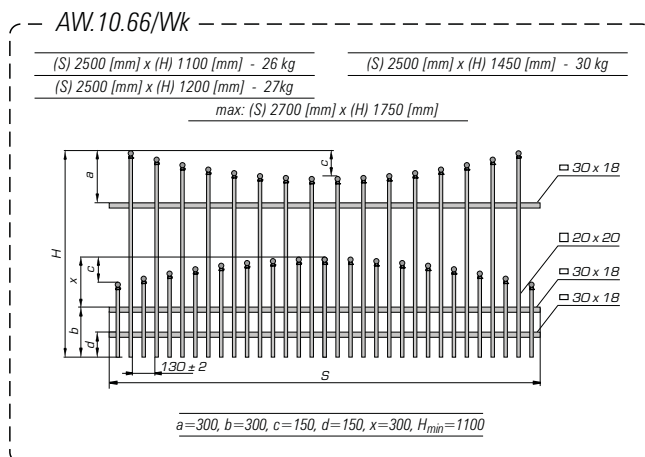
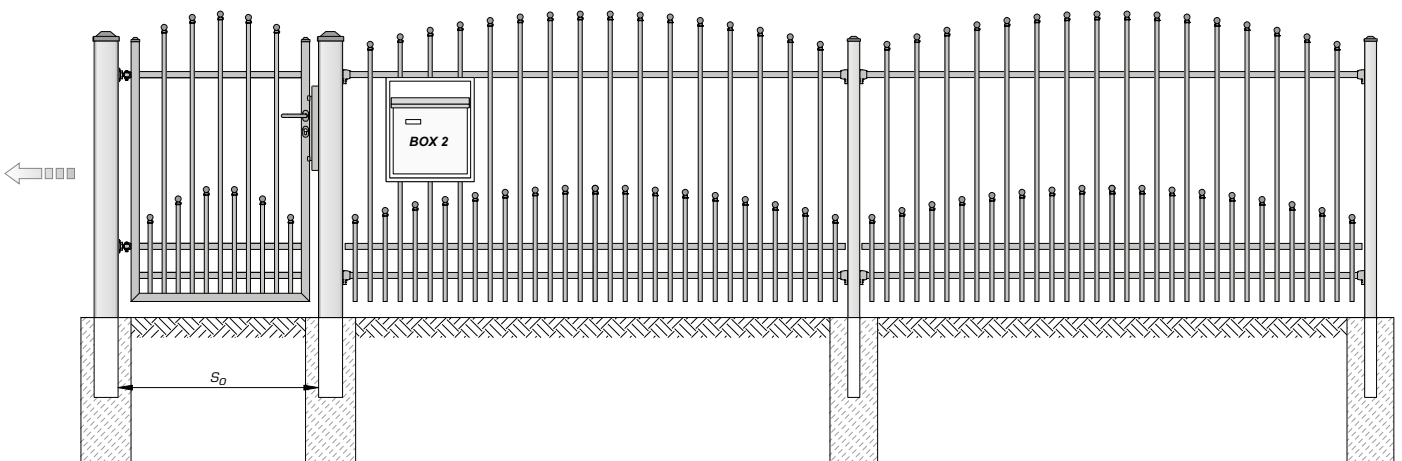
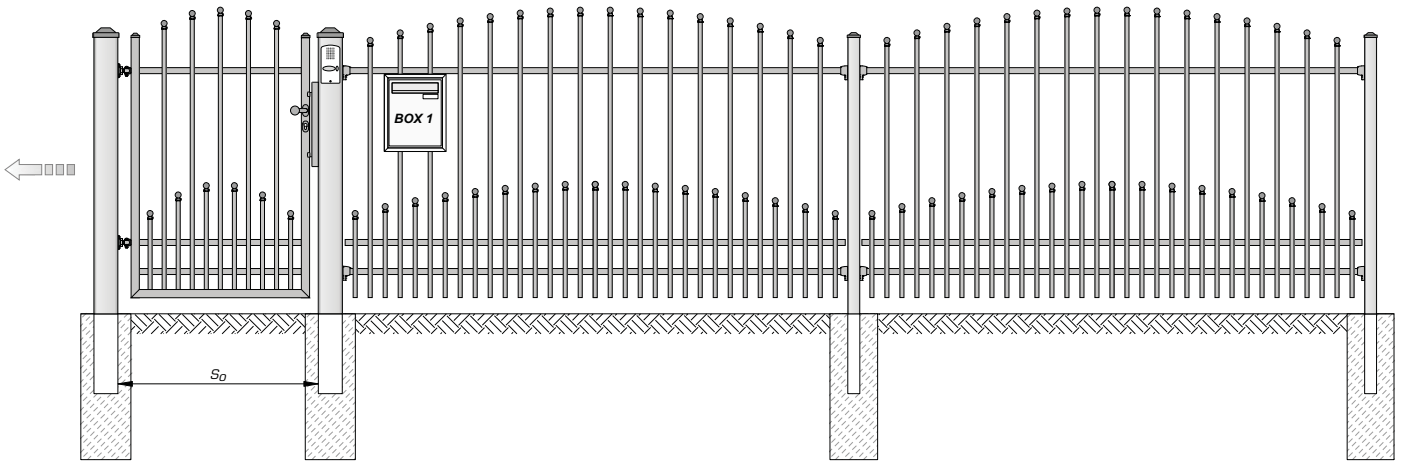

U6 C 20x20 D 30x18